

**SULZER**

Sulzer Pumps

## ABS Turbocompressor HST 20

The compressor  
that expands  
premium performance



The Heart of Your Process

**abs**

# The New Generation of World-Class Turbocompressor

Sulzer Pumps has long been the leader in turbocompressors for the wastewater industry. This leadership is cemented by the new ABS turbocompressor HST 20, which represents our third generation of fully air-cooled turbo-compressor technology.

Sulzer Pumps was the first with direct-driven high-speed turbo-compressors for wastewater aeration processes, which we introduced nearly twenty years ago. Most competitors have supplied direct-driven turbo-compressors for a few years at most, and none share our strict focus on municipal wastewater applications.

With over 1500 direct-driven turbo-compressors at many hundreds of satisfied customers worldwide, we possess the largest base of machines and expertise in the wastewater industry.

## Advances Built on Proven Technology

Turbocompressors from Sulzer Pumps have a solid reputation for quality and reliability. Our technology, which is 100% air-cooled, has been tried and tested in almost two decades of operation.

The knowledge acquired in those years is a part of the ABS turbo-compressor HST 20. As the third generation of our proven technology, it takes our well-known strengths to new levels. Key advantages of the ABS turbo-compressor HST 20 include:

- **Exceptional savings from wire to air**

The ABS turbocompressor HST 20 offers truly outstanding wire-to-air efficiency. This gives you the most air output for every kilowatt you put in – which saves you money and speeds up payback. The efficiency comes from optimizing the turbo-compressor as a whole, rather than targeting individual components.



- **Stable efficiency with magnetic bearings**

Magnetic bearings allow the ABS turbocompressor HST 20 to be run in a safe and controlled manner with small impeller clearances. They run less risk of damage, pose no service difficulties and consistently safeguard your operating efficiency.

- **Compact and cost-effective installation**

The ABS turbocompressor HST 20 is a completely integrated and practically noiseless package. The air cooling system, outlet diffuser, silencers and more are all incorporated into the cabinet, which eliminates costly accessories and makes the turbocompressor easy to install.

Once in operation, maintenance is limited to regular check-ups and an occasional change of the air filter. This is a huge contrast to screw compressors and positive displacement blowers, which require costly and extensive overhauls to retain efficiency and functionality.

- **Intuitive control that optimizes your process**

The control system of the ABS turbocompressor HST 20 is nothing less than groundbreaking. As well as providing a clear overview and visualizing necessary actions on the touchscreen display, it uses stored process data to help operators make far-reaching improvements.





### Part of the ABS EffeX Revolution

The ABS EffeX revolution is an ongoing effort from Sulzer Pumps to push the boundaries of wastewater technology, especially in the area of energy efficiency. Encompassing the whole chain from design to manufacturing, it has resulted in the most innovative and resource-conserving solutions on the market.

The revolution began in 2009 with the launch of the ABS submersible sewage pump XFP. Since then, it has expanded to comprise a complete range of world-class wastewater products. Their energy savings, reduced carbon footprint and high reliability contribute to efficient processes and satisfy the growing demands placed on the wastewater industry.

The **ABS EffeX** Revolution continues

# Exceptional Savings From Wire to Air

Looking at the entire turbocompressor, rather than the individual efficiencies of impellers and other features, is the only way to ensure overall performance and cost-effective operation. The ABS turbocompressor HST 20 is a balanced system with the best total output for your energy input.

## Seeing the Big Picture

In an application representing 70% of a wastewater facility's energy use, every percentage saved makes a big difference to the bottom line. For the greatest savings, it is important to view the turbocompressor as a whole. A machined impeller, for example, has a 1-5% better design efficiency than a cast impeller. But the impeller is one part of a complete system that operates under dynamic conditions. What saves energy and money is the system efficiency in real life, from the wire going in to the air coming out.

## Complete Energy Savings

The ABS turbocompressor HST 20 focuses on system efficiency in all conditions, not component efficiencies in an ideal world. Compared to conventional competitors, its system efficiency is 10% higher in real-life operation – which results in faster payback.

This achievement derives from not one, but many factors:

- Premium-efficiency motor**  
 The high-speed permanent-magnet motor, which is developed in-house, provides efficiency at levels proposed for IE3 / IE4 / NEMA 2.
- Fine-tuned speed control**  
 In-house expertise in the use of variable-frequency drives to run high-speed motors results in optimized control of the permanent-magnet motor.
- Newly designed impeller**  
 Computational fluid dynamics (CFD) have been used to refine the impeller, which is machined from a single block of dural aluminum for the greatest possible efficiency and strength.
- Optimized labyrinth seal**  
 A new seal design minimizes energy losses in this sensitive area.
- Digitally controlled magnetic bearings**  
 Additional features make the bearing system even more stable, precise and efficient.

## 20-Year Lifecycle Analysis

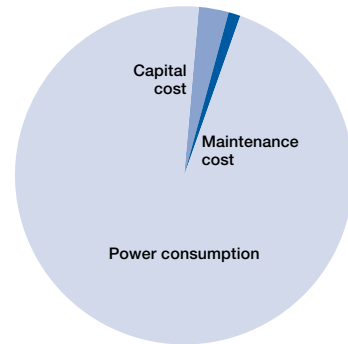

## Turndown Efficiency

Full capacity is seldom required, so turbocompressors are often “turned down” to a lower operating level. The ABS turbocompressor HST 20 has a good individual turndown rate, but turbocompressors usually operate in groups. Groups are easier to control in a cost-effective way, which means even turndown should be viewed as a whole.

Applying the individual turndown of all machines in a group can lead to a system with substandard performance at low or average flow. When less capacity is needed, efficiency should be optimized across the group, by selecting the number and flow of running compressors to minimize overall power consumption.

Sulzer Pumps developed this sort of modular control, and our proven technology ensures parallel operation with efficient turndown in all situations.

## Lifecycle Cost

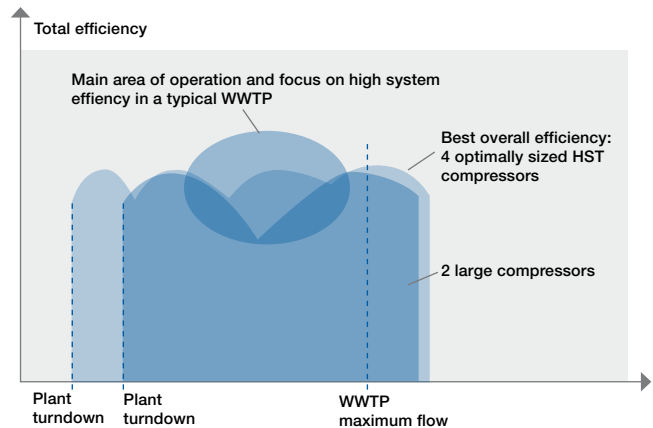
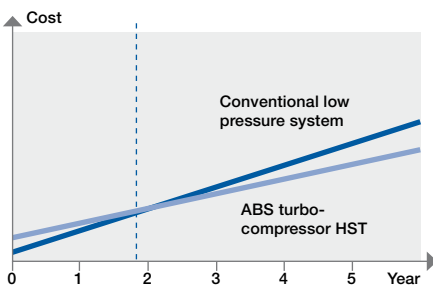

Four optimally sized HST compressors achieve better turndown.

# Stable Efficiency With Magnetic Bearings

Sulzer Pumps pioneered the use of oil-free magnetic bearings, which offer better stability and performance than conventional air bearings. Our bearings are developed and produced in-house for efficient, problem-free and cost-competitive operation.

## Where Air Bearings Fail

Air bearings are an older technology with disadvantages in larger machines. Though effective in dental drills and air cycle machines, they struggle with the high forces in a turbocompressor. This leads to efficiency-lowering compromises, for example in the labyrinth seal. When small tolerances, difficult service, sensitivity to heat and particles, and wear during start and stop are also considered, air bearings fall well short of their magnetic counterparts.

## Magnetic Bearing Advantages

The magnetic bearings of the ABS turbocompressor HST 20 are a modern technology with no tradeoffs. In contrast to air bearings, they offer the following key advantages:

- A tighter labyrinth seal, which dramatically improves overall efficiency
- More stable operation, due to greater bearing clearances and damping
- Longer component life, thanks to wear-free starts and stops
- Increased protection from damaging process surges
- Virtually no losses due to friction

Even their energy efficiency is superior. While energy is used to power the magnets, the losses in air bearings due to friction and axial forces are easily equal or greater.

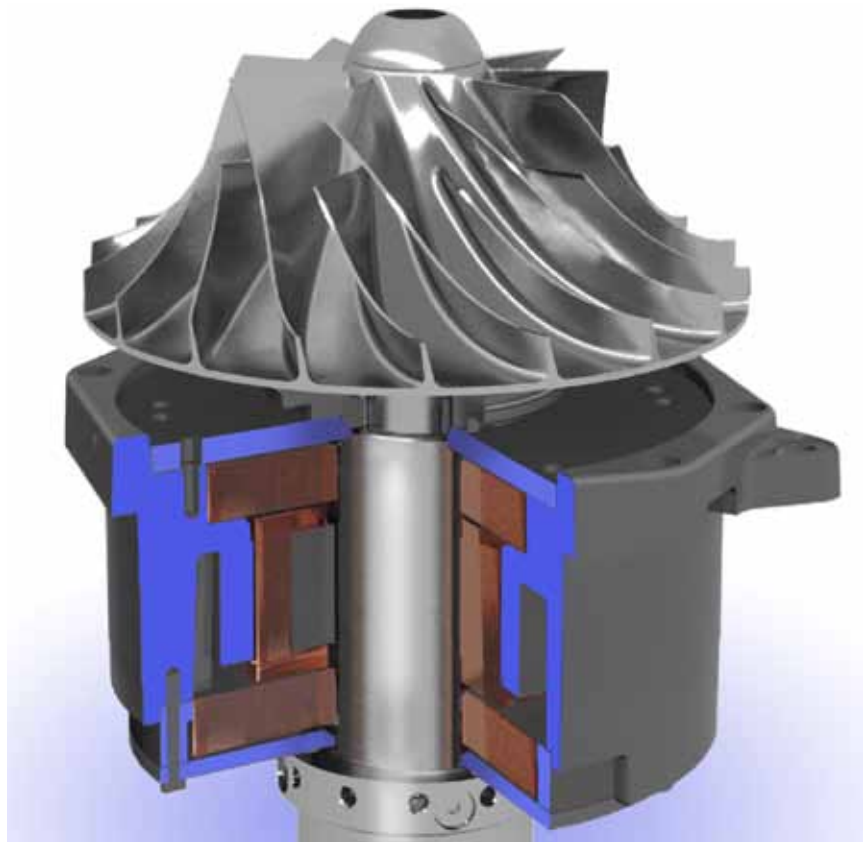

**Sulzer Pumps leads the way in magnetic bearings, which offer substantial operating advantages over the air bearings used by competitors.**

## Technology to Rely On

The magnetic bearings of the ABS turbocompressor HST 20 are the third generation of our leading technology. This means they are not only efficient, but also proven and reliable. Though seldom if ever needed, the bearings have three levels of backup:

- Generator power supplied by the machine's own motion
- Battery power
- Touchdown bearings, which effectively take up pressure shocks

The bearings are also regulated by a digital bearing controller. By monitoring the shaft's axial motion in five directions, the controller brings additional accuracy to the already stable operation.

# Compact and Cost-Effective Installation

With its uniquely integrated design, the ABS turbocompressor HST 20 makes installation both less complicated and less expensive. Once in operation, it is practically maintenance-free.

## A Complete Package

All major equipment for the ABS turbocompressor HST 20 is already found in the cabinet. There is no vertical discharge pipe, since the use of magnetic bearings allows a vertical shaft and horizontal discharge. And there are hardly any accessories. Nearly everything is built in – from the air inlet and air cooling to the outlet diffuser and silencers.

## Small and Silent

With nothing to add to the length or height, the installation has a minimal bulk and footprint. This is good news for older facilities, where space is limited and low ceilings make pipes and silencers a problem. New facilities can build smaller blower houses with less insulation, and all facilities save costs and resources through the reduction in stainless steel piping.

For operators, the most important reduction is the one in noise, which the built-in silencers keep to 70 dBA.

## Simple and Self-Sufficient

Preparing an installation is easy, thanks to digital dimensioning tools based on real-world performance data. Only one power cable is needed, which can be drawn from the roof above or the floor below. Both power connection points are sealed, which prevents the ingress of moisture and particles.

Built-in blow-off valve

Built-in diffuser and silencer  
(low noise: 70 dBA)

Built-in air intake silencer

Once installed, the unit can be practically forgotten. Immune to temperature shifts, voltage fluctuations and changes in atmospheric pressure, its maintenance is limited to regular check-ups and an occasional change of the air filter.

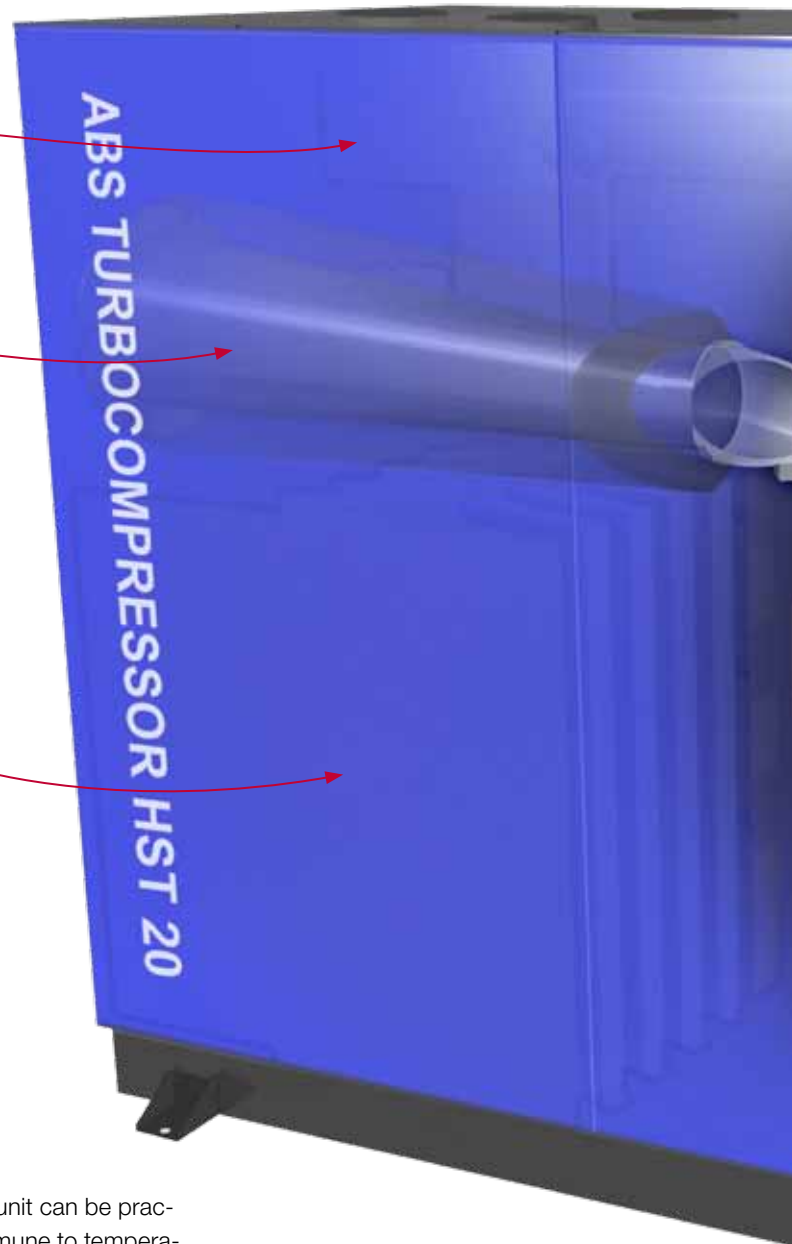

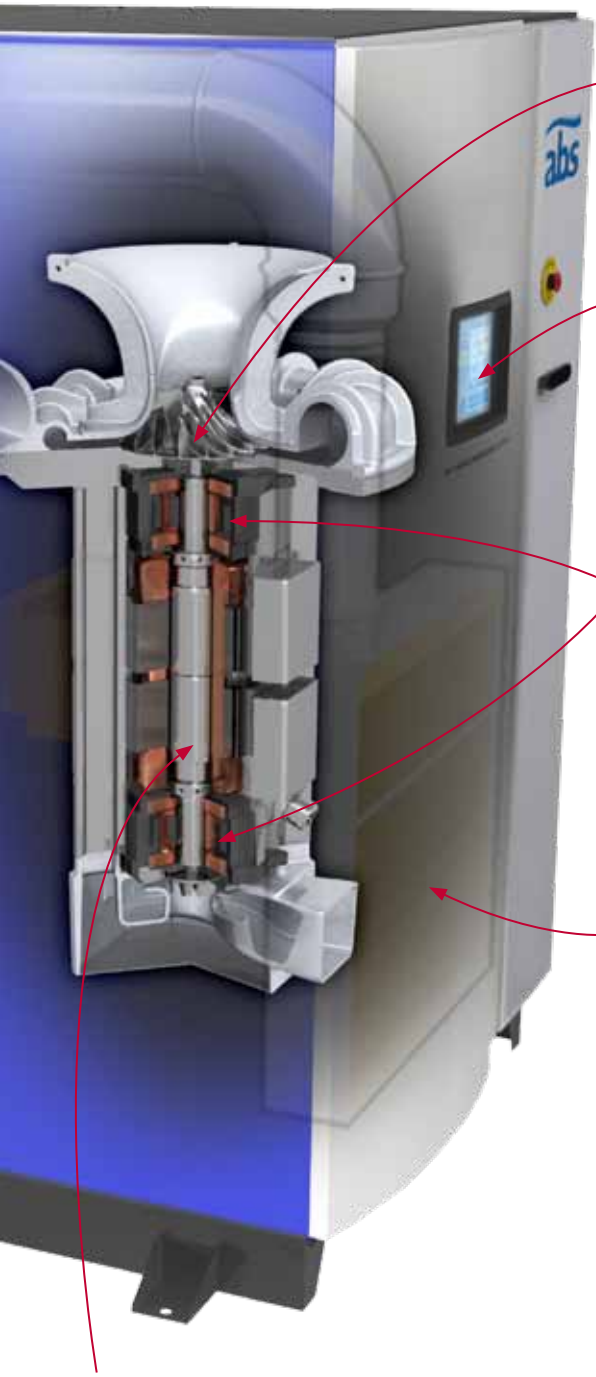

Newly designed turbo impeller and labyrinth seal (both 3<sup>rd</sup> generation)

New intuitive HMI

Magnetic bearing system (3<sup>rd</sup> generation)

Built-in cooling air silencers

Premium-efficiency, high-speed permanent-magnet motor (3<sup>rd</sup> generation)

### Low Maintenance – A Lifetime Advantage

The fact that the ABS turbocompressor HST 20 requires so little maintenance can make a huge financial difference over time. This is especially true in comparison to screw compressors and positive displacement blowers.

Neither screw compressors nor positive displacement blowers approach the efficiency of a turbocompressor. Moreover, their ability to provide even reasonable efficiency depends on the screws or lobes meshing accurately. Since dry screws and lobes are required to produce oil-free air for the wastewater market, wear is inevitable and accuracy and efficiency are quickly lost.

To restore efficiency and to keep them operable, screw compressors and positive displacement blowers need expensive overhauls that may cost 60% of the initial investment. So whatever the purchase price, just one such overhaul causes costs to skyrocket.

The ABS turbocompressor HST 20 provides consistently higher efficiency than screw compressors and positive displacement blowers, and it does so without costly maintenance. As a result, it offers a far lower lifecycle cost.

# Intuitive Control That Optimizes Your Process

The role of Sulzer Pumps as a fore-runner is affirmed by the control system of the ABS turbocompressor HST 20. Not only does the control system have a groundbreaking visual interface, it also helps you improve surrounding processes.

## Self-Diagnostic Control

Operation of the ABS turbocompressor HST 20 is smooth and simple. The turbocompressor has its own compressor control system, which is designed in-house for optimal function. When part of a turbocompressor pair, the control system can be linked to another for seamless, two-as-one operation.

The control system provides self-diagnostic functions, so it can stop the turbocompressor if critical conditions arise. In addition, it continuously records operating data, which can be used for process optimization.

## Human-Machine Interface (HMI)

Central to the control system is an intuitive HMI, with a 7-inch color touchscreen providing the right information at just the right time. At a glance, the operator can see that the turbocompressor is functioning ideally, or that an action such as filter exchange will soon be necessary.

As standard, the values for flow, pressure and power are always visible on screen. But the operator can also customize the display, adding and removing parameters or changing their order of appearance. The operator can switch between multiple languages or metric and imperial units, or access a built-in manual in digital form.



The HMI touchscreen can be instructed by the operator to show:

- A variety of process parameters (flow, pressure and power as standard)
- Multiple languages
- Metric or imperial units
- An integrated digital manual

## Access via Other Systems

Naturally, the control system of the ABS turbocompressor HST 20 has Ethernet capability. This allows connection to a PC, either locally or via Internet. Various field bus options are

also provided, which enables connection of the turbocompressor to different plant automation systems. When connected in this way, the relevant functions of the turbocompressor can be accessed through these systems too.







### Optimizing Aeration Processes

Data saved by the control system becomes suggestions for process improvement. The ABS turbocompressor HST 20 monitors its environment and identifies problems before they occur, with issues and their location visualized on the HMI display.

In most cases, the issues are not in the turbocompressor, but in the pipes, valves and other equipment surrounding it. Pressure shocks, for example, can usually be traced to the timing of air distribution valves. With the turbocompressor as a guide, operators can work proactively to increase uptime and efficiency.

# Delivering World-Class Performance

The ABS turbocompressor HST 20 is part of a complete, world-class product range from Sulzer Pumps. Gathered under the ABS EffeX name, the range embodies our unique drive to define the leading edge of wastewater technology.

## Leading Wastewater Innovation

Sulzer Pumps is a wastewater specialist with outstanding customer relations and extensive application expertise. As the only supplier on the market with a complete range of premium-efficiency wastewater equipment, we lead the way in solving the challenges faced by municipal, industrial, commercial, and domestic end-users.

Our ABS product brand is synonymous with innovation and well-proven solutions for wastewater collection and treatment. Nothing makes this clearer than the ABS EffeX range.

## The ABS EffeX Revolution

The ABS EffeX range targets legislative demands to reduce energy use and carbon footprint. Yet it also meets fast-changing needs within wastewater collection and treatment. In addition to using premium-efficiency motors, we address the causes of blockage and the effects of reduced water consumption and changing personal hygiene habits.

Balancing these concerns is what keeps costs low and service levels high. The ABS EffeX range provides the most efficient, reliable operation possible – which gives you full peace of mind.

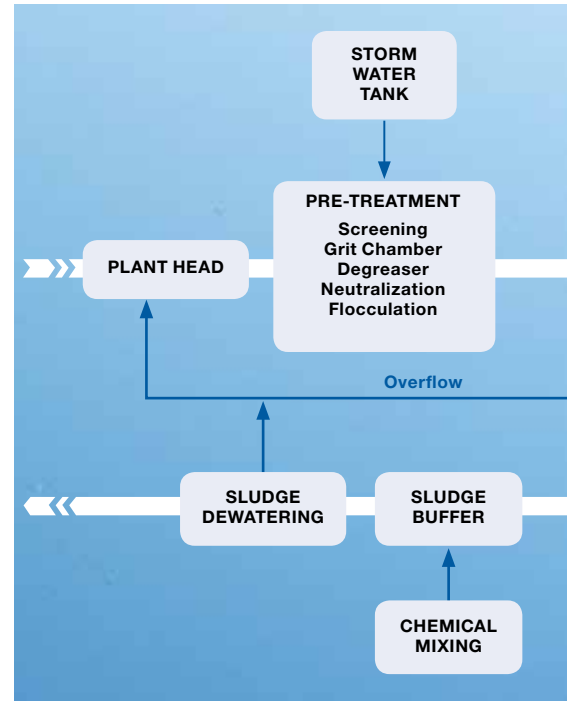

## The World-Class Range of Wastewater Products

The ABS EffeX range from Sulzer Pumps is a complete portfolio of products designed to cover all key aspects of wastewater handling. It includes:

- Submersible sewage pumps
- Submersible mixers
- Submersible flow boosters
- Turbocompressors
- Modular pump control systems

All of these products employ premium-efficiency motors (IE3 or equivalent), as well as innovative features that ensure efficiency and reliability.



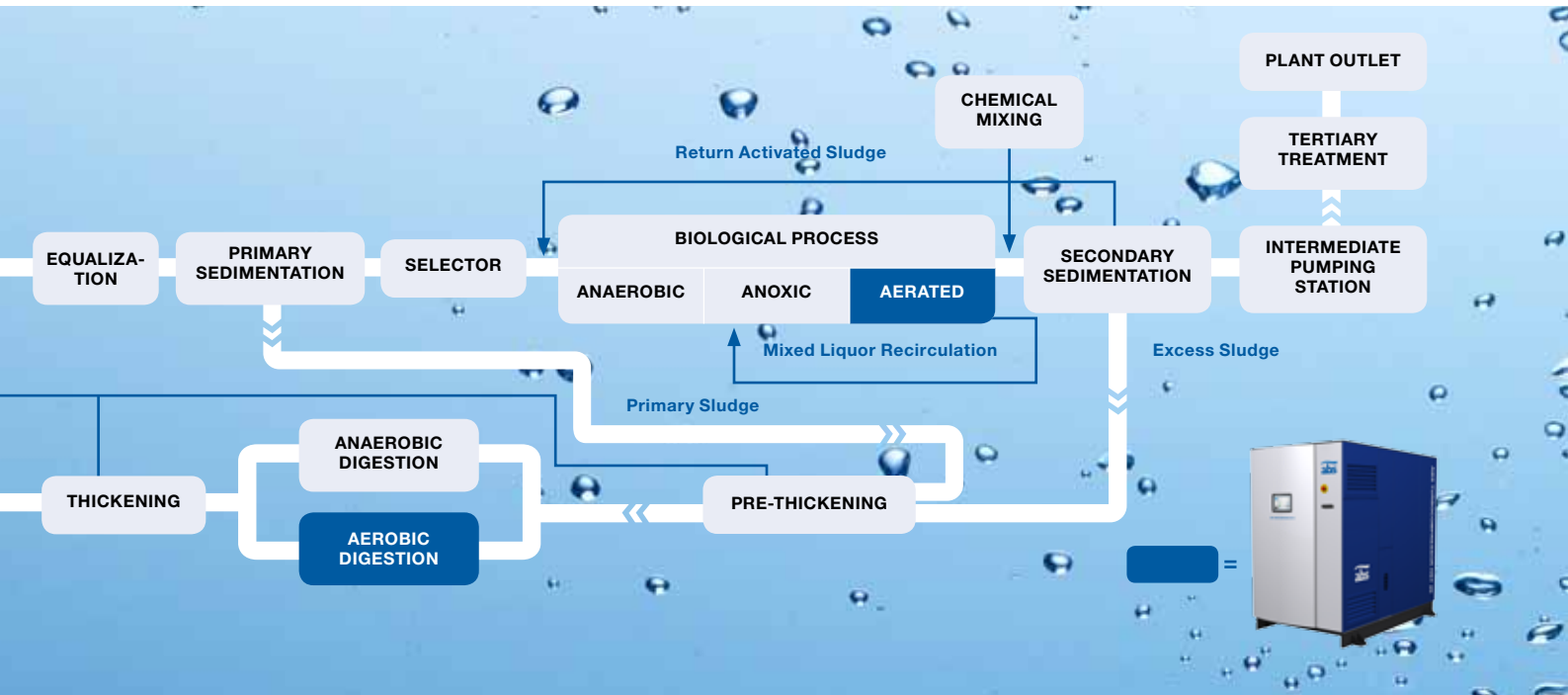

### Service Globally and Locally

Sulzer Pumps is a strong global organization, represented worldwide with a strong local presence.

We offer a complete Service Program, covering everything from on-site repair to full service maintenance contracts with alarm management and 24-hour breakdown services.

In addition, we have a sophisticated stocking system with international hub locations and on-hand stocks of key products. This ensures products are rapidly and reliably available whenever they are needed on site.

ABS turbocompressor HST 20	
<b>Airflow range</b>	2000–7000 Nm <sup>3</sup> /h / 1300–4400 SCFM
<b>Pressure rise</b>	30–90 kPa / 4–13 psig
<b>Input power</b>	125–190 kW / 150–250 hp
<b>Max. current (400 V)</b>	112–309 A
<b>Power supply</b>	380 V / 400 V / 480 V / 500 V / 580 V / 600 V / 690 V
<b>Input frequency</b>	50 Hz / 60 Hz
<b>Protection class</b>	IP33D / NEMA 2
<b>Thermal protection</b>	PT100
<b>Max. noise level</b>	70 dBA

## Combined Strength for Unmatched Expertise

ABS, associated with innovation and well proven solutions for wastewater handling and dewatering, is a product brand of Sulzer. Strong customer service combined

with extensive application expertise in solving wastewater and dewatering challenges is the foundation of this strong global brand. For more information, visit [www.sulzer.com](http://www.sulzer.com)

[www.sulzer.com](http://www.sulzer.com)



E10143 en (1) 10.2012, Copyright © Sulzer Pumps

This brochure is a general presentation. It does not provide any warranty or guarantee of any kind. Please, contact us for a description of the warranties and guarantees offered with our products. Directions for use and safety will be given separately. All information herein is subject to change without notice.